

Song Title:

Key:

Song Form:

Mode Form:

A

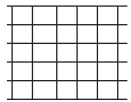
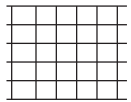
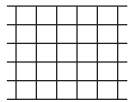
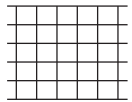
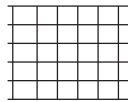
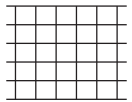

B

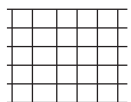
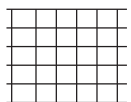
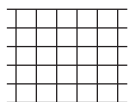
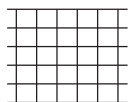
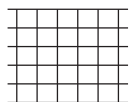
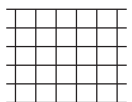

C

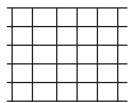
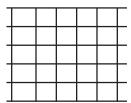
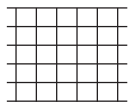
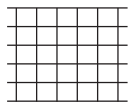
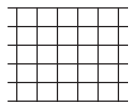
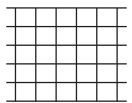

D

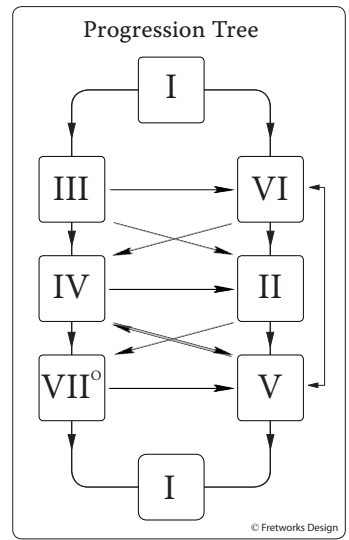
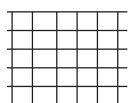
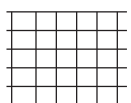
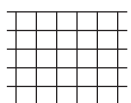
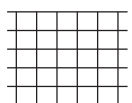
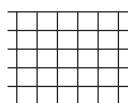
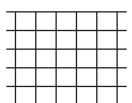

Common Progressions

Common Song Forms

Primary Mode

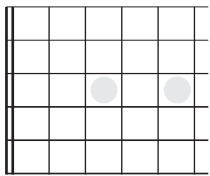

Mode: \_\_\_\_\_

Alternative Mode

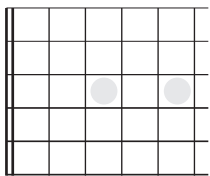

Mode: \_\_\_\_\_

I

II

III

IV

V<sup>(7)</sup>

VI

VII

